

Qty.	Description
------	-------------

1	UPS 50-185 F
---	--------------



Note! Product picture may differ from actual product

Product No.: 96430300

The pump is of the canned rotor type, i.e. pump and motor form an integral unit without shaft seal and with only two gaskets for sealing. The bearings are lubricated by the pumped liquid.

In order to avoid problems in connection with disposal, great importance has been attached to using as few different materials as possible.

The pump is characterized by:

Speed no: * 3 speed motor.

- * Ceramic radial bearings.
- * Carbon axial bearing.
- * Stainless steel rotor can, bearing plate and rotor cladding.
- * Aluminium alloy stator housing.

Pump housing: * Cast iron pump housing.

- * Stator with built-in thermal switch.

Phase: The motor is a 1-phase motor.

The pump is supplied with a standard module in the terminal box.

The standard module is to be connected to the mains supply via external contactor.

Controls:

Relay: without relay

Liquid:

Pumped liquid: Water

Liquid temperature range: -10 .. 120 °C

Selected liquid temperature: 60 °C

Density: 983.2 kg/m³

Technical:

Approvals on nameplate: AAA,EAC

Materials:

Pump housing: Cast iron
EN-JL1040
ASTM 35 B - 40 B

Impeller: Stainless steel
DIN W.-Nr. 1.4301
AISI 304

Installation:

Range of ambient temperature: 0 .. 40 °C

Qty.	Description
	Maximum operating pressure: 10 bar
	Flange standard: DIN
	Pipe connection: DN 50
	Pressure rating: PN 6 / PN 10
	Port-to-port length: 280 mm
	Electrical data:
	Power input in speed 1: 1150 W
	Power input in speed 2: 1240 W
	Max. power input: 1290 W
	Mains frequency: 50 Hz
	Rated voltage: 1 x 230-240 V
	Current in speed 1: 5.6 A
	Current in speed 2: 6.05 A
	Current in speed 3: 6 A
	Cos phi in speed 1: 0.89
	Cos phi in speed 2: 0.89
	Cos phi: 0.93
	Capacitor size - run: 30 μ F/400 V
	Insulation class (IEC 85): H
	Enclosure class (IEC 60529): X4D
	Others:
	Net weight: 28 kg
	Gross weight: 29.1 kg
	Shipping volume: 0.043 m ³

96430300 UPS 50-185 F 50 Hz

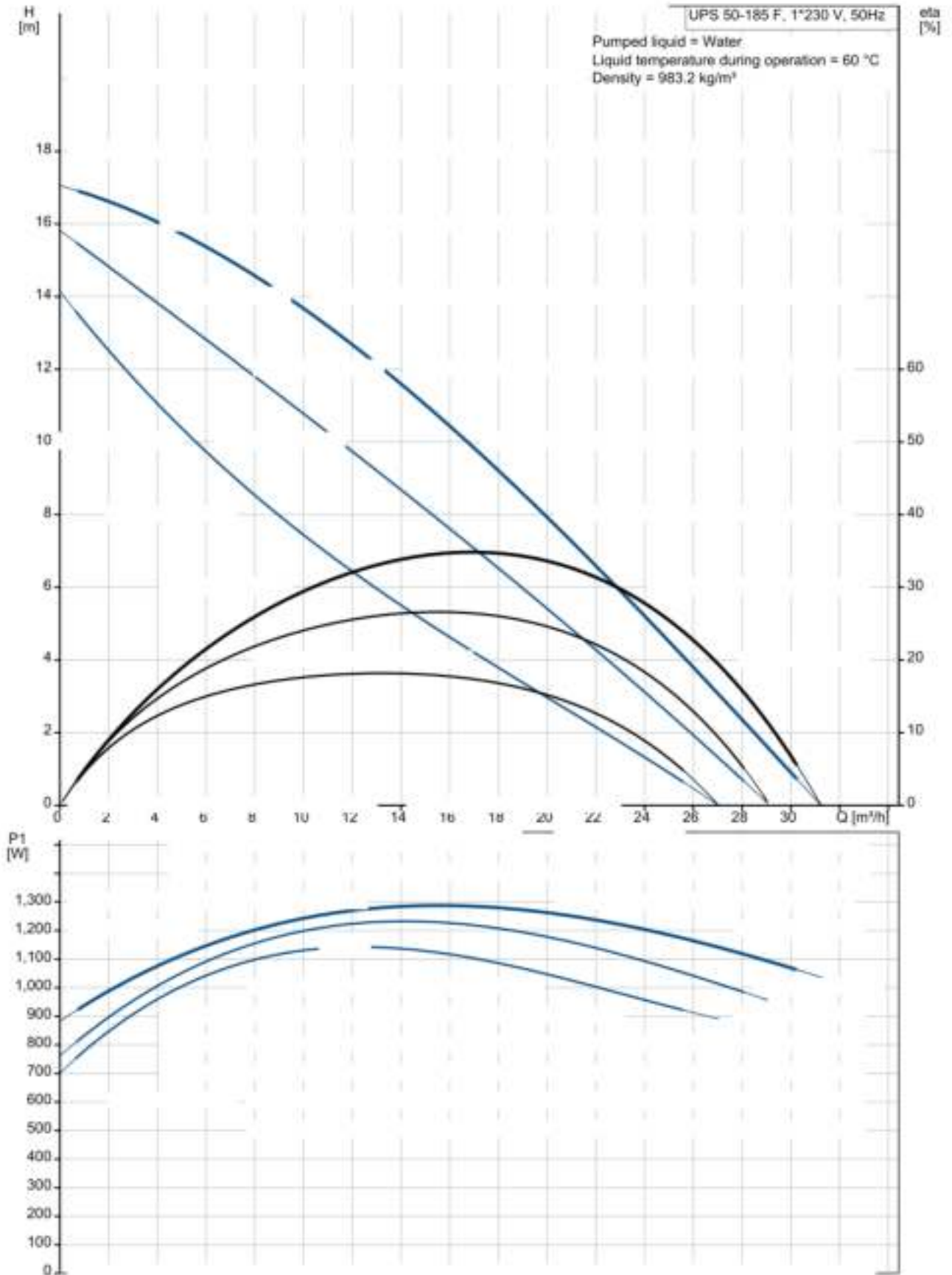

Description	Value
General information:	
Product name:	UPS 50-185 F
Product No:	96430300
EAN number:	5700392948137
Price:	
Technical:	
Speed no:	3
Head max:	185 dm
Approvals on nameplate:	AAA,EAC
Materials:	
Pump housing:	Cast iron
Pump housing:	EN-JL1040
Pump housing:	ASTM 35 B - 40 B
Impeller:	Stainless steel
Impeller:	DIN W.-Nr. 1.4301
Impeller:	AISI 304
Installation:	
Range of ambient temperature:	0 .. 40 °C
Maximum operating pressure:	10 bar
Flange standard:	DIN
Pipe connection:	DN 50
Pressure rating:	PN 6 / PN 10
Port-to-port length:	280 mm
Liquid:	
Pumped liquid:	Water
Liquid temperature range:	-10 .. 120 °C
Selected liquid temperature:	60 °C
Density:	983.2 kg/m ³
Electrical data:	
Power input in speed 1:	1150 W
Power input in speed 2:	1240 W
Max. power input:	1290 W
Mains frequency:	50 Hz
Rated voltage:	1 x 230-240 V
Current in speed 1:	5.6 A
Current in speed 2:	6.05 A
Current in speed 3:	6 A
Cos phi in speed 1:	0.89
Cos phi in speed 2:	0.89
Cos phi:	0.93
Capacitor size - run:	30 µF/400 V
Insulation class (IEC 85):	H
Enclosure class (IEC 60529):	X4D
Motor protec:	CONTACT
Thermal protec:	external
Controls:	
Relay:	without relay
Pos term box:	1.30H
Others:	
Net weight:	28 kg
Gross weight:	29.1 kg
Shipping volume:	0.043 m ³

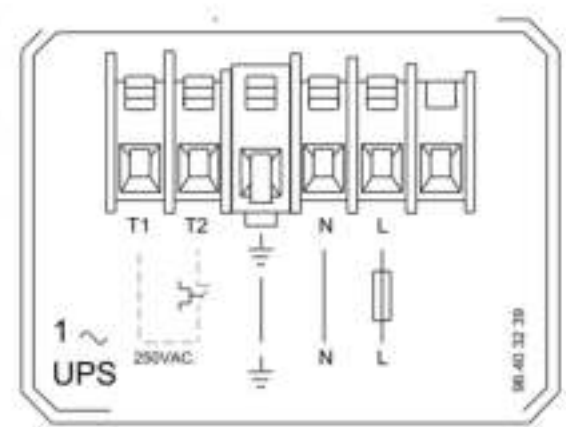
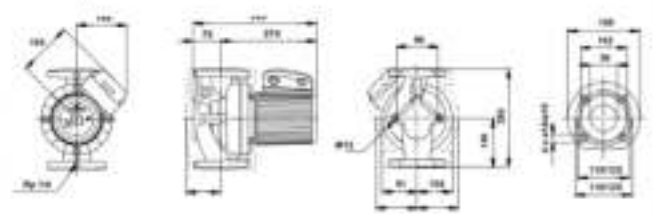
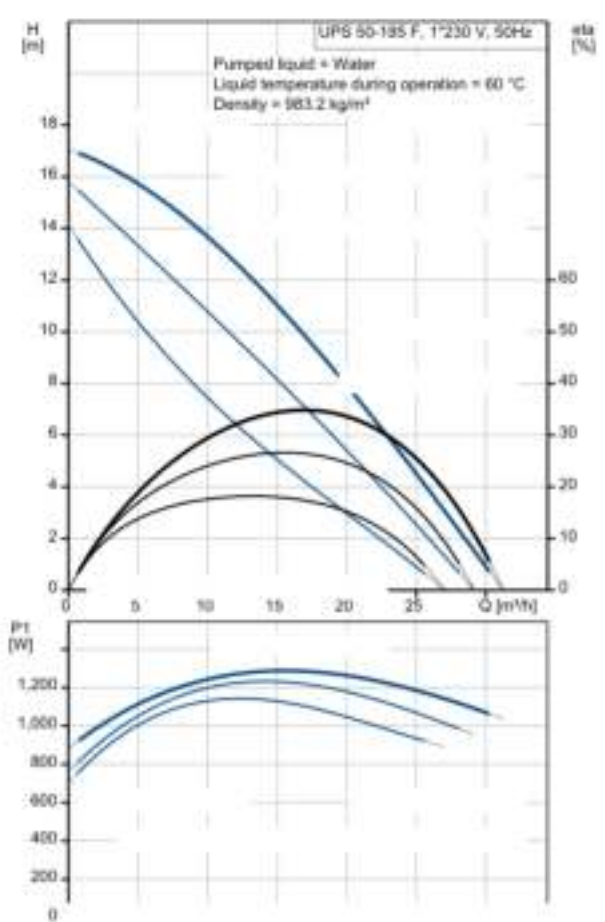

96430300 UPS 50-185 F 50 Hz

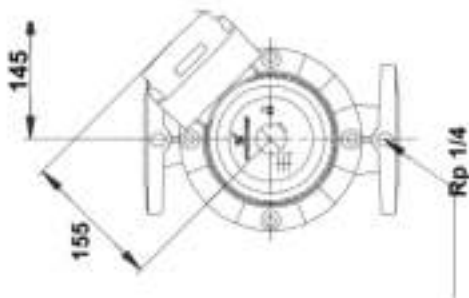
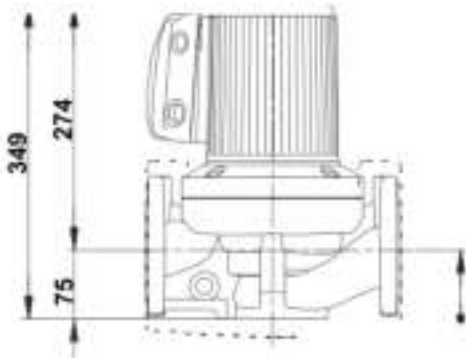
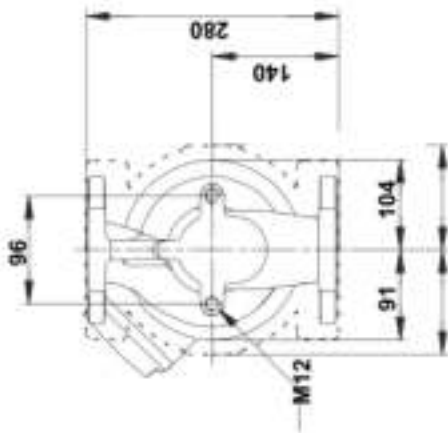
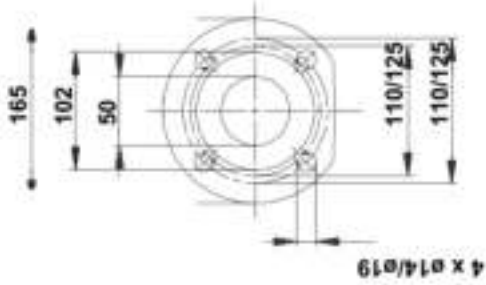

Note! All units are in [mm] unless others are stated.
Disclaimer: This simplified dimensional drawing does not show all details.

96430300 UPS 50-185 F 50 Hz

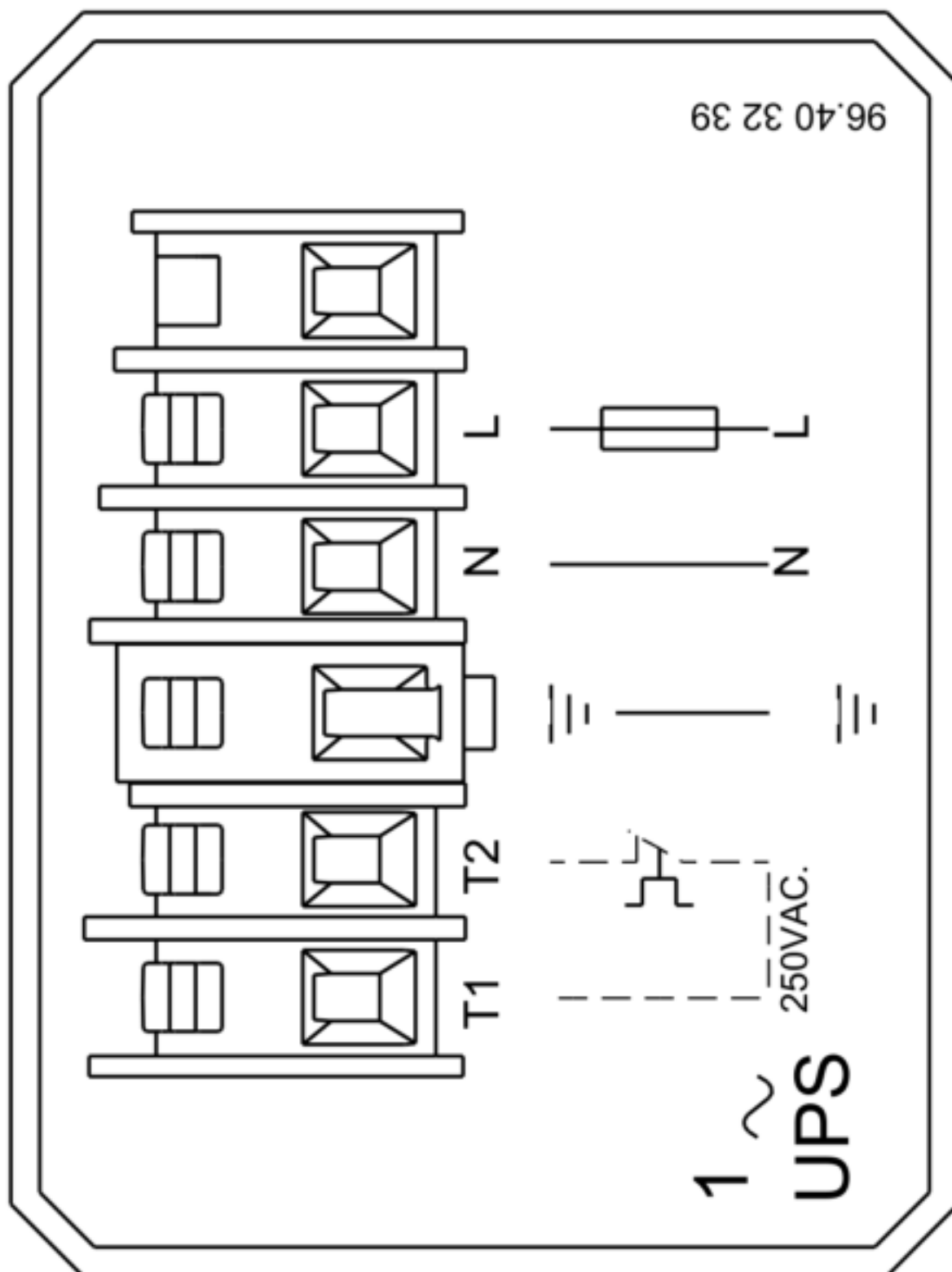

Note! All units are in [mm] unless others are stated.